

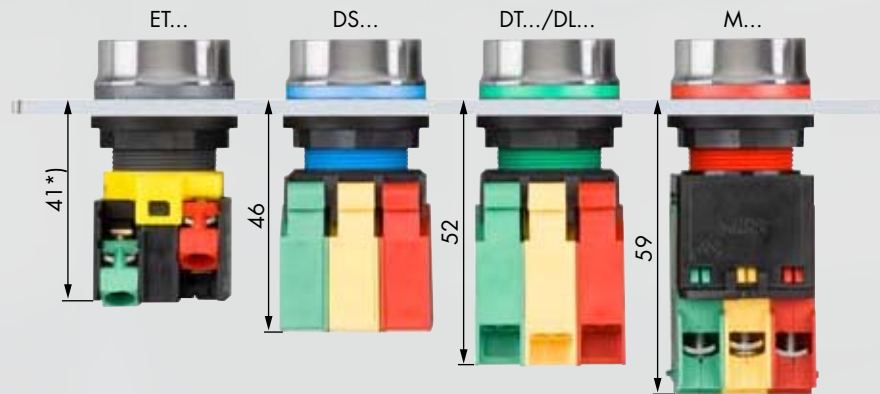

Mounting Depth Dimensions



* ETR2 61mm, ETLR 50mm, ETLR2 70mm, EL9R 36mm

Cutout Dimensions

Mounting grid acc. to DIN EN 50007

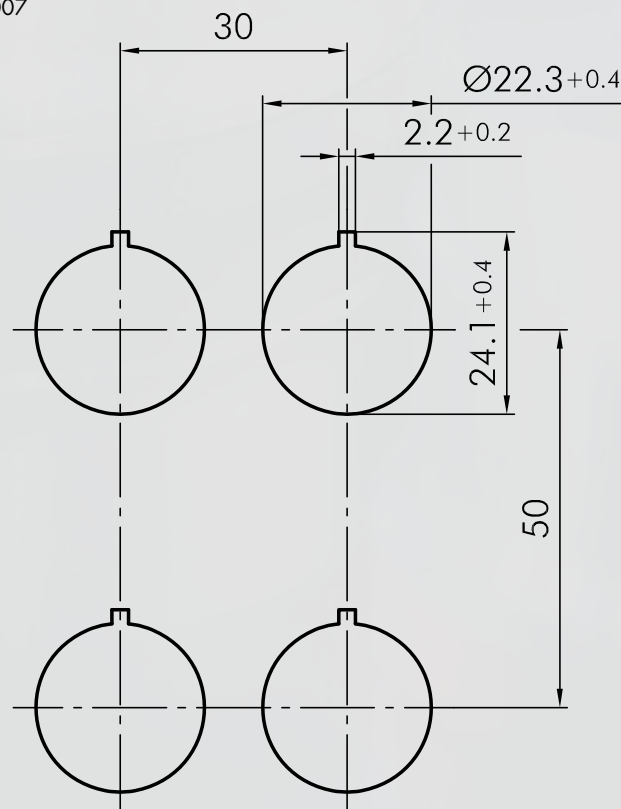

	RVAN...	RVASSAI2E...	RVASSAI3E...	RVASSAI4E...	RVASSAI5E...	RVASSAI7E...	RVASSAI8E...	RVASTB...	RVAT...	RVATL...	RVAWA...	RVAWB...	RVAWC...
DL	●									⓪			
DSL9	●									●			
DSTI					●	●			⓪	●	●		
DSTO					●	●			⓪	●	●		
DTI		⓪	⓪	⓪	⓪	⓪	⓪	⓪	⓪	⓪	⓪	⓪	⓪
DTIV		⓪	⓪	⓪	⓪	⓪	⓪	⓪	⓪	⓪	⓪	⓪	⓪
DTO		⓪	⓪	⓪	⓪	⓪	⓪	⓪	⓪	⓪	⓪	⓪	⓪
DTON		⓪	⓪	⓪	⓪	⓪	⓪	⓪	⓪	⓪	⓪	⓪	⓪
DZL	●									⓪			
DZTI		⓪	⓪	⓪	⓪	⓪	⓪	⓪	⓪	⓪	⓪	⓪	⓪
DZTIV		⓪	⓪	⓪	⓪	⓪	⓪	⓪	⓪	⓪	⓪	⓪	⓪
DZTO		⓪	⓪	⓪	⓪	⓪	⓪	⓪	⓪	⓪	⓪	⓪	⓪
DZTON		⓪	⓪	⓪	⓪	⓪	⓪	⓪	⓪	⓪	⓪	⓪	⓪
EL9R	●												
ETLR										●			
ETLR2										●			
ETR		●	●	●	●	●	●	●	●	●	●	●	●
ETR2		●	●	●	●	●	●	●	●	●	●	●	●
MF									●	●			
MFL										●			
ML	●									●			
MLED230B	●									●			
MLED230G	●									●			
MLED230R	●									●			
MLED230W	●									●			
MLED230Y	●									●			
MLED24B	●									●			
MLED24G	●									●			
MLED24R	●									●			
MLED24W	●									●			
MLED24Y	●									●			
MT97									●	●			
MTI		②	②	②	②	②	②	④	●	●	●	●	●
MTIV									●	●	●	●	●
MTM		●	●					●				●	●
MTO		②	②	②	②	②	②	④	●	●	●	●	●
MTON			②						●	●	●	●	●
MTZU									●				
MZL	●									●			
MZTI		②	②	②	②	②	②	④	●	●	●	●	●
MZTO		②	②	②	②	②	②	④	●	●	●	●	●

- possible combination
- optimal combination
- ⓪ max. 1 modular contact element can be snapped into centre position
- ⓪ max. 2 modular contact elements per level, to be snapped into outer positions 1+3
- ② max. 2 modular contact elements
- ③ max. 3 modular contact elements (foolproofness guaranteed)
- ④ max. 4 modular contact elements
- ⓪ please add *_497 to the actuator type ref.

Pushbutton Heads (momentary/push-push)

The housing (visible edging) and the luminous spot are supplied in green-GN, red-RT, blue-BL, yellow-GB, black-SW, white-WS or charcoal-DG (clear luminous spot). Add code letter to type number, e.g. RVAT_RT.
Selector Heads (momentary/maintained)

I = Switching position

> = Spring return

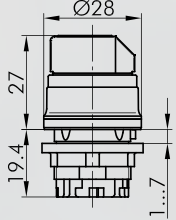

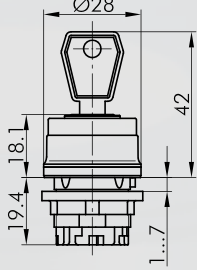
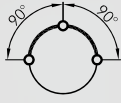

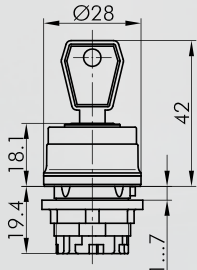
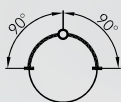

Illustration	Dimensions	Description	Type
<p>IP69K 6mm</p>	<p>Ø28 12.2 19.4 1...7</p>	<p>Pushbutton Head front bezel metallic</p>	RVAT...
<p>IP69K 6mm</p>	<p>Ø28 12.2 19.4 1...7</p>	<p>Illuminated Pushbutton Head front bezel metallic</p>	RVATL...
<p>IP69K</p>	<p>Ø28 27 19.4 1...7</p>	<p>Selector Head front bezel metallic</p>	<p>90° RVAWA...</p>
<p>IP65</p>	<p>Ø28 27 19.4 1...7</p>	<p>Selector Head front bezel metallic</p>	<p>45° 45° RVAWB...</p>
<p>IP65</p>	<p>Ø28 27 19.4 1...7</p>	<p>Selector Head front bezel metallic</p>	<p>45° 45° RVAWC...</p>

Control Units
Bus Technology
Limit Switches
Pedal Switches
Emergency Stop

Selector Heads (momentary/maintained)

The housing (visible edging) and the luminous spot are supplied in green-GN, red-RT, blue-BL, yellow-GB, black-SW, white-WS or charcoal-DG (clear luminous spot). Add code letter to type number, e.g. RVASTB_RT.
Key Actuators (momentary/maintained)

- I = Switching position
- > = Spring return
- = Key removable position

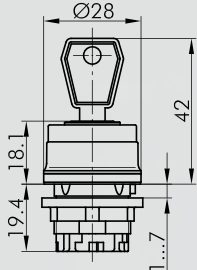
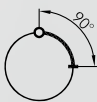
Illustration	Dimensions	Description	Type
		<p>Selector Head, momentary front bezel metallic</p>	 <p>RVASTB...</p>
		<p>Key Actuator including two keys front bezel metallic</p>	 <p>RVASSA12E...</p>
		<p>Key Actuator including two keys other lock types on request front bezel metallic</p>	 <p>RVASSA13E...</p>
		<p>Key Actuator including two keys other lock types on request front bezel metallic</p>	 <p>RVASSA14E...</p>

Key Actuators (momentary/maintained)

The housing (visible edging) is supplied in green-GN, red-RT, blue-BL, yellow-GB, black-SW, white-WS or charcoal-DG. Add code letter to type number, e.g. RVASSA15E_RT.

Pilot Light Heads/Pilot Lights

- I = Switching position
- > = Spring return
- = Key removable position

Illustration	Dimensions	Description	Type
		<p>Key Actuator including two keys other lock types on request front bezel metallic</p>	<p>RVASSA15E...</p>
		<p>Key Actuator including two keys other lock types on request front bezel metallic</p>	<p>RVASSA17E...</p>
		<p>Key Actuator including two keys other lock types on request front bezel metallic</p>	<p>RVASSA18E...</p>
		<p>Spare Keys please specify key number</p>	<p>ESE...</p>
		<p>Pilot Light Head front bezel metallic</p>	<p>RVAN...</p>

Accessories for Actuators

Illustration	Dimensions	Description	Type
		Mounting Tool with torque limitation for the series QUARTEX-R-(JUWEL), KOMBITAST-R, RONDEX, RONDEX-M, RVA, DUX-Basic	S22
		Mounting Tool Adapter with 1/4" connections for mounting tools S16 and S22	SRA
		Lamp Remover for incandescent lamps FZR9...	LZ8
		Universal Lens Remover	USK