

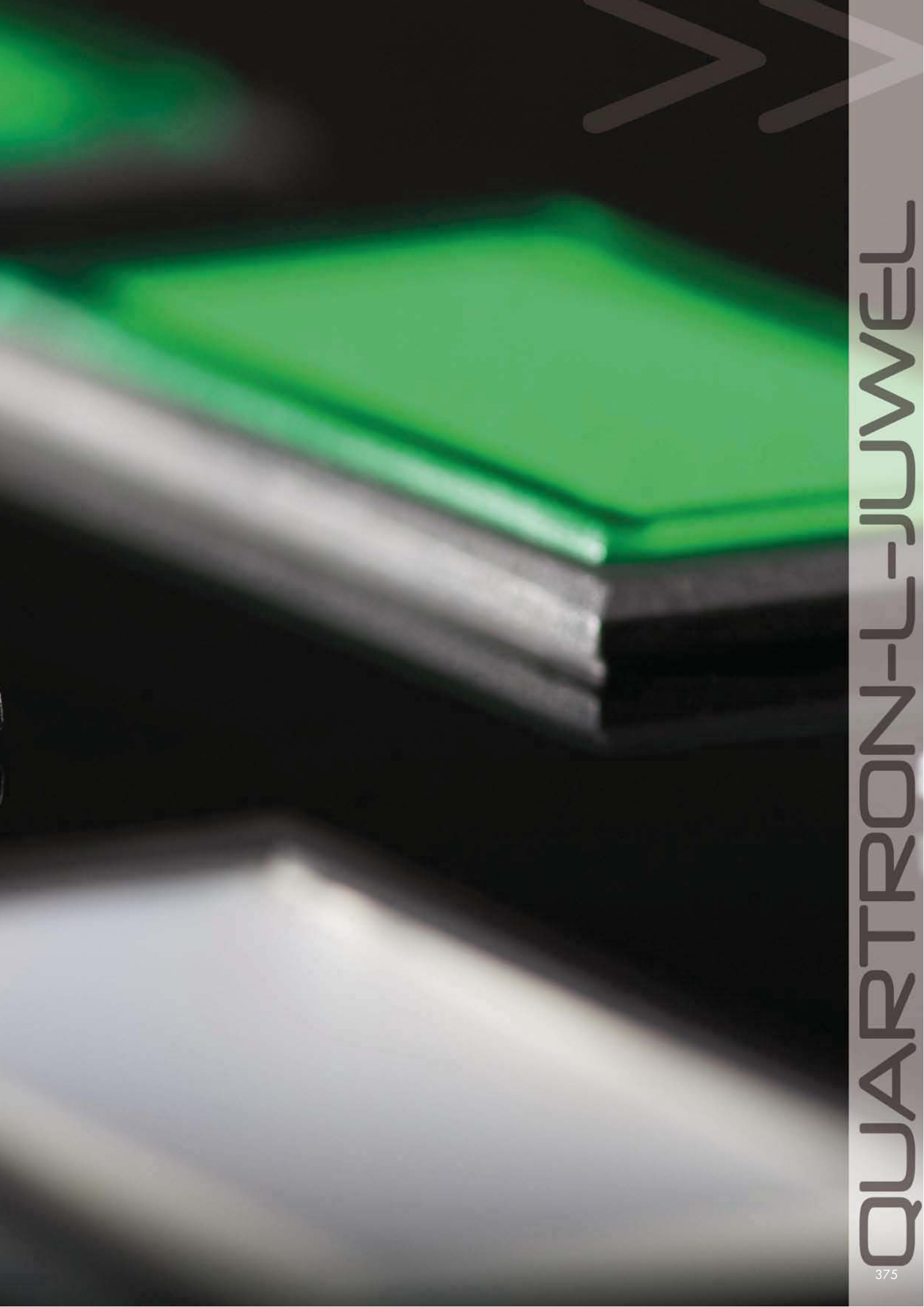

Front dimensions: 54 x 27 mm  
Panel cut-out: 48 x 24 mm  
Front bezel height: 2.5 mm  
Travel: 6 mm



# QUARTZTRON-L-JUWEL

## Mounting Depth Dimensions

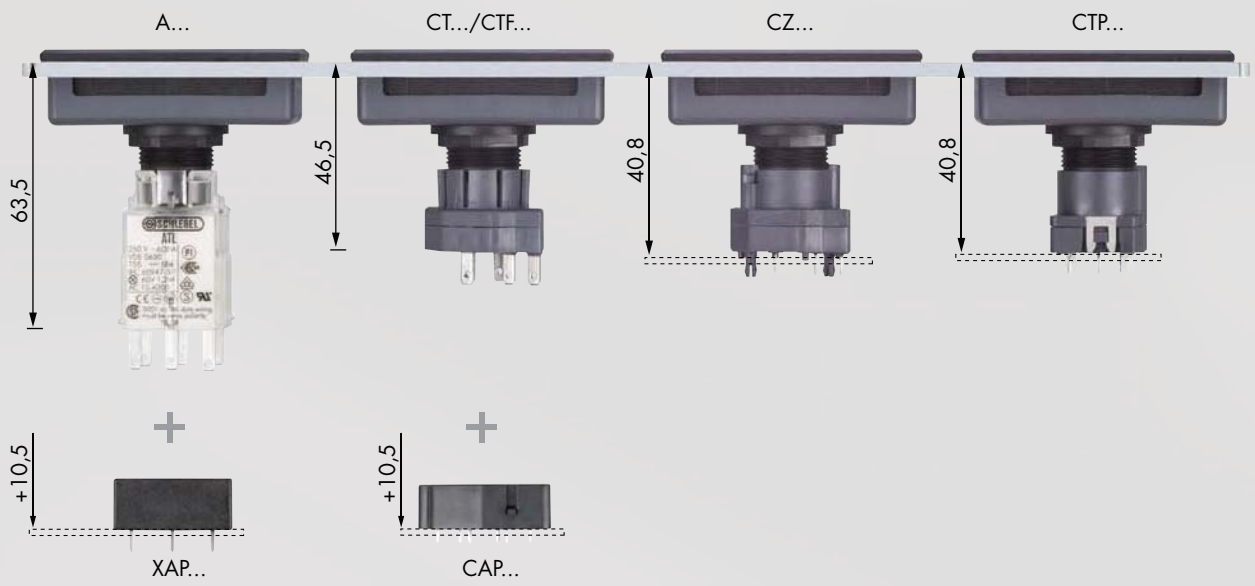

## Cutout Dimensions

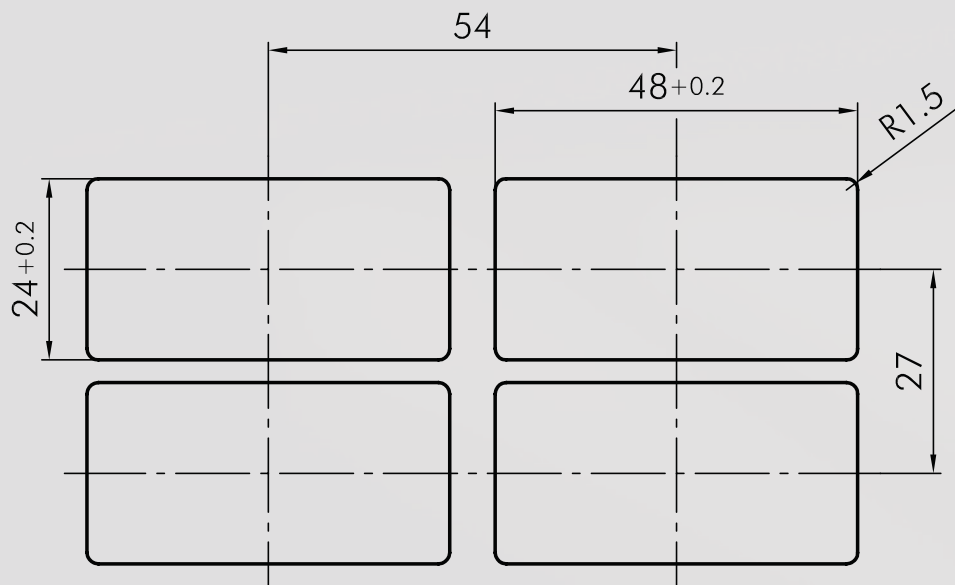

	LXJL5	LXJN	LXJT	LXJTT
AF			●	●
AF2			●	●
AFL			●	●
AFL2			●	●
AL5		●		
AL5-220		●		
AT			●	●
AT2			●	●
ATI			●	●
ATL			●	●
ATL2			●	●
ATO			●	●
AZ011_97			●	●
AZ2			●	●
AZOO			○	○
AZOW1			○	○
CL		●		
CLP_485		●		
CT			○	○
CT2			○	○
CTF			○	○
CTL			○	○
CTL2			○	○
CTLF			○	○
CTLP_485			○	○
CTP_485			○	○
CZLP		●		
CZTLP			○	○
CZTLP2			○	○
CZTP			○	○
CZTP2			○	○
L5		●		
PTFOI			○	○
PTFOO			○	○
PTPOI			○	○
PTPOO			○	○

- possible combination  
● optimal combination

# QUARTRON-LJUWEL

24 x 48 mm



## Pushbutton Heads (momentary/push-push)

Lenses and nameplates to be ordered separately

Illustration

Dimensions

Description

Type

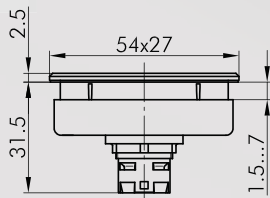

### Pushbutton Head 54 x 27 mm

front bezel      black  
                         charcoal

**LXJT**  
**LXJTDG**



### Concave Lens, transparent

available in blue-BL, yellow-GB, green-GN, clear-KL,  
red-RT, opalwhite-WS,  
add code letter to type number, e.g. T50DBL

**T50D...**



### Flat Lens, transparent

available in blue-BL, yellow-GB, green-GN, clear-KL,  
red-RT, opalwhite-WS,  
add code letter to type number, e.g. T50FBL

**T50F...**



### High Lens, transparent

available in blue-BL, yellow-GB, green-GN, clear-KL,  
red-RT, opalwhite-WS,  
add code letter to type number, e.g. T50HBL

**T50H...**



### Nameplate

with standard imprint, please specify index number  
(see nameplates)

**BSLX...**



### Nameplate

with special imprint according to customer's specifications

**BSLXB**

## Pushbutton Heads (momentary/push-push)

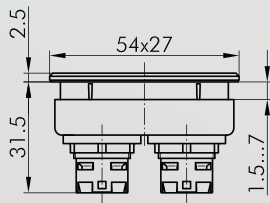
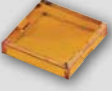
Lenses and nameplates to be ordered separately

Illustration	Dimensions	Description	Type
		<b>Blank Nameplate</b>	<b>BSLXU</b>
 		<b>Double Pushbutton Head 54 x 27 mm</b> front bezel      black charcoal	<b>LXJTT</b> <b>LXJTTDG</b>
		<b>Concave Lens, transparent</b> available in blue-BL, yellow-GB, green-GN, clear-KL, red-RT, opalwhite-WS, add code letter to type number, e.g. T25DBL	<b>T25D...</b>
		<b>Flat Lens, transparent</b> available in blue-BL, yellow-GB, green-GN, clear-KL, red-RT, opalwhite-WS, add code letter to type number, e.g. T25FBL	<b>T25F...</b>
		<b>Flat Lens, non-transparent</b> used in pushbuttons without inscription and illumination, available in blue-BL, yellow-GB, green-GN, black-SW, red-RT, white-WS, add code letter to type number, e.g. T25FGWS	<b>T25FG...</b>
		<b>High Lens, transparent</b> available in blue-BL, yellow-GB, green-GN, clear-KL, red-RT, opalwhite-WS, add code letter to type number, e.g. T25HBL	<b>T25H...</b>



- Index
- About Us
- Control Units
- Actuators
- Bus Technology
- Endboxes
- Limit Switches
- Pedal Switches
- Terminal Blocks

# QUARTRON-LJUWEL

24 x 48 mm



## Accessories for Actuators

Illustration	Dimensions	Description	Type
		<b>Nameplate</b> with standard imprint, please specify index number (see nameplates)	<b>BSQX...</b>
		<b>Nameplate</b> with special imprint according to customer's specifications	<b>BSQXB</b>
		<b>Blank Nameplate</b>	<b>BSQXU</b>
	IP67	<b>Sealing Cap</b> made of silicone rubber, down to -50°C	<b>TK55S</b>

- Index
- Mount Us
- Control Units
- Actuators
- Bus Technology
- Enclosures
- Limit Switches
- Pedal Switches
- Terminal Blocks

## Pilot Light Heads/Pilot Lights

Lenses and nameplates to be ordered separately

Illustration

Dimensions

Description

Type

IP65



### Pilot Light 54 x 27 with Faston terminals 2.8x0.8 mm

T5.5K socket

front bezel

black

charcoal

**LXJL5**

**LXJL5DG**

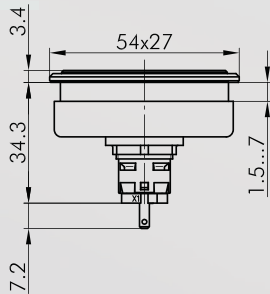

IP65

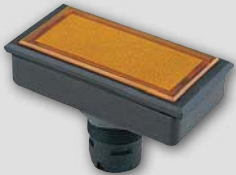

### Pilot Light Head 54 x 27 mm

front bezel

black

charcoal

**LXJN**

**LXJNDG**

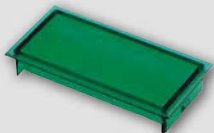
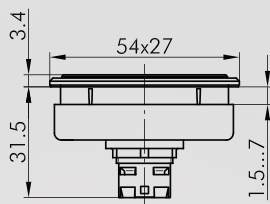

### Flat Lens, depolished

available in blue-BL, yellow-GB, green-GN, clear-KL,  
red-RT, opalwhite-W5,  
add code letter to type number, e.g. KF50BL

**KF50...**



### Flat Lens, transparent

available in blue-BL, yellow-GB, green-GN, clear-KL,  
red-RT, opalwhite-W5,  
add code letter to type number, e.g. KF50KSBL

**KF50KS...**



## Accessories for Actuators

Illustration

Dimensions

Description

Type



### Nameplate

with standard imprint, please specify index number (see nameplates)

**BSLX...**

### Nameplate

with special imprint according to customer's specifications

**BSLXB**



### Blank Nameplate

**BSLXU**

Index

Accessories

Control Units

Bus Technology





Enclosures

Limit Switches

Pedal Switches

Terminal Blocks

## Accessories for Actuators

Illustration	Dimensions	Description	Type
		<b>Hexagonal Mounting Tool</b> with torque limitation, for the series OKTRON, OKTRON-JUWEL, OKTRON-R, RONTRON-R-JUWEL, RONTRON-R- Exclusive, RONTRON-Q-JUWEL, RONTRON-Q- Exclusive, QUARTRON(-L), QUARTRON-JUWEL(-L), RX, RX-JUWEL	<b>S16</b>
		<b>Mounting Tool Adapter with 1/4\" connections</b> for mounting tools S16 and S22	<b>SRA</b>
		<b>Lamp Remover</b>	<b>LZ-MG</b>
		<b>Universal Lens Remover</b>	<b>USK</b>